

USE AND MAINTENANCE

Reference	Type	Description
7141	STRIKE	STRIKE recessed manhole, in pre-galvanized Z200 metal sheet th. 15/10, PPC finishing, c/w frame th. 15/10 and kit for patented lifting system with retractable rollaway handle.

INSTALLATION

HANDLE INSTALLATION

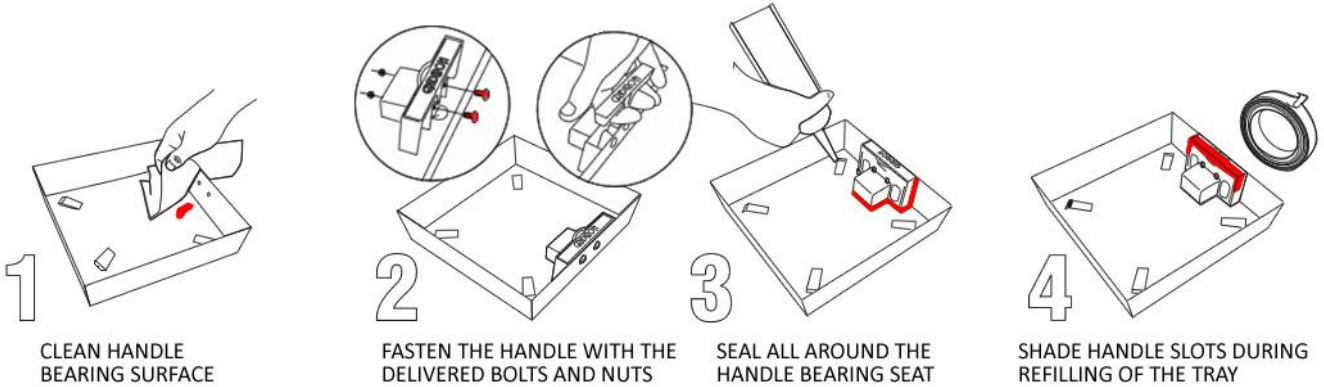

PERIODIC MAINTENANCE



WE RECCOMEND TO LIFT THE HANDLE AND REMOVE ANY WASTE WITHIN THE TRAY BY MEANS OF A HAND TOOL



INSTRUCTION:

Installation must be carried out by expert personnel equipped with suitable equipment for lifting heavy loads.

If the manhole cover weighs 30 kg or less, it can be moved by hand, though the assistance of two operators is recommended.

- 1 - Make sure that the installation surface is intact and capable of withstanding the load to be applied on it.
- 2 - Make sure that there is enough space to the sides of the sump unit for casting the concrete.
- 3 - Mount the lifting system included in the package (cap/handle).
- 4 - Use a tool (flat-head screwdriver, chisel, trowel, etc.) to bend outwards the press-formed tangs on the sides of the frame and inside the filling bucket.
- 5 - Extract the bucket and fill it using the same material and technique used for side-filling.
- 6 - Allow enough time for the concrete material to set (follow the manufacturer's instructions), then insert the bucket into the frame.
- 7 - If necessary, complete the work by adding a slab to reach the final level.

ADVICE:

For filling purposes, use the following types of concrete:

C25/30 XF2

C28/35 XF4 in case of temperatures $\leq 0^{\circ}\text{C}$

- In case of drive-over manhole covers, insert a steel reinforcing mesh inside the bucket before filling with concrete material.
- The filled bucket must be inserted carefully inside the frame; if necessary, use suitable lifting equipment.
- It is advisable to first mount the frame without the bucket inside it.
- Cut wooden slats to fit the inner dimensions of the frame and insert them across the latter to prevent it from deforming while the concrete sets.
- In case of galvanised manhole covers laid on ceramic paving, using fillers and adhesives with $\text{pH} > 11$; metal surfaces should be protected in advance with silicone spray.

WARNINGS

- Strictly observe all the manufacturer's instructions described in this document.
- Do not use the product in ways other than those for which it was intended.
- Do not in any way tamper with the product or any other component.
- Make sure that the product has no structural defects; if it does, immediately notify the supplier.
- Make sure that the type of item matches that requested by the designer.
- Make sure that parts designed to be buried in cement are free of residues of oil, grease, glue, etc.
- Do not join components made of different metals (e.g. galvanised steel with stainless steel), as this combination in damp environments may lead to corrosion. If the above materials must be used, it is advisable to place an insulating layer between them.

GALVANISED STEEL MANHOLE COVERS

- It is important to verify the characteristics of the adhesives used for paving, in particular that their pH value falls between 6 and 11.
- Use quick-setting adhesives, or adhesives that dry fully within 7 days.
- Be careful not to damage the surface treatment of the steel product or any of its components.
- Do not use aggressive cleaning products, in particular check that their pH value falls between 6 and 11.

MAINTENANCE

MAINTENANCE SHOULD BE CARRIED OUT AT LEAST ONCE A YEAR

- 1 - Check that the lifting system works properly and, if possible, clean and lubricate it. If it has any broken parts hampering its operation, contact the supplier.
- 2 - Remove the bucket.
- 3 - Clean the inside of the frame by removing any debris, leaves, stones, gravel, etc.
- 4 - Put the bucket back in place.

DISPOSAL

Regarding disposal, consult the applicable regulations for recovering any materials compatibly with the environment, and observe all local regulations.

Moreover, we recommend contacting a specialised waste disposal company.