

## USAGE AND MAINTENANCE

<b>ASSEMBLED CODE</b>	4R10SGG
<b>DESCRIPTION</b>	Vibro-compressed concrete channel MOD. R495, with galvanized protective edge rails, c/w n. 2 x GJS500-7 ductile iron gratings, dim. 490x500 H40 mm, installed and locked, painted. Channel runoff section sqcm. 1390. Load class E600 according to EN 1433:2008 Norm, if installed following manufacturer instructions.
<b>PRODUCT LINE</b>	Drainage channel type "M"
<b>SERIES TYPE</b>	R series 495
<b>LOADING CLASS</b>	E600 - EN 1433:2008

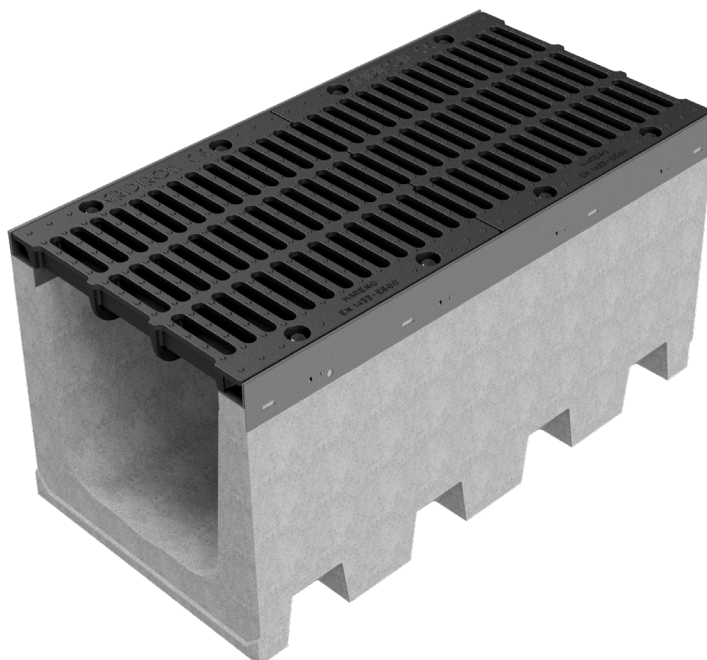
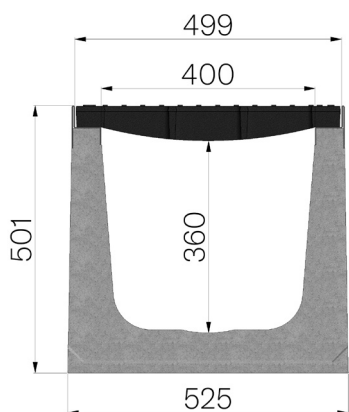

## INSTALLATION

Installation must be carried out by competent personnel and equipped with suitable equipment for lifting heavy loads. The UNI EN 1433:2008 standard stipulates that the load-bearing capacity of the channel depends on the grating, the channel and correct installation, so the following operations must be carried out with great care.

- Dig out a trench of suitable dimensions for housing the chosen channel.
- Place the suitable reinforcing mesh.
- Cast a concrete base having the appropriate thickness and inclination.
- Insert reinforcing bars into the subgrade that will serve as the connection between the subgrade and the backfill.
- Once the subgrade is cured, pour a thin layer of concrete, and directly bed the channel on it.
- Channels complete with gratings should be laid and connected one after the other using the appropriate male/female joint, checking their alignment and dimensions.
- Reinforce the channels with concrete.

The above operations are better specified according to the table and laying scheme below.

## WARNINGS

- Lay channels using lifting clamps or certified straps suitable for the weight of the channel to be moved.
- Pay attention to the correct positioning of the lifting clamps or straps.
- Check that the weight of the channel is properly distributed, and proceed with lifting (see Figure 1).
- For the subgrade and backfill, use concrete with strength values according to the tables, in case of temperatures less than or equal to 0°C, use concrete in class xf4 according to uni-en 206 standards.
- Lay the channels always starting from the drainage point.
- Channels are equipped with a male/female joint, apply sealant to the appropriate slot in the male joint (see Figure 2).
- We recommend the use of neutral cross-linking silicone sealant, which provides perfect adhesion and permanent elasticity.
- Make sure the covers/grids are in their proper place and tightly screwed down before pouring the channel backfill.
- Always keep the finished pavement 3-5 mm higher than the channel.
- Strictly observe all the manufacturers instructions described in this document.
- Do not use the product in ways other than those for which it was intended.
- Do not in any way tamper with the channel or any of its constituent parts.
- Make sure that the product has no structural defects; if it does, immediately notify the supplier.
- Make sure that the type of item matches that requested by the designer.

### GALVANISED STEEL PROFILES AND/OR COVERS

- It is important to verify the characteristics of the adhesives used for paving, that their pH value falls between 6 and 11; if not, the metal surfaces should be protected in advance with silicone spray
- Use quick-setting adhesives, or adhesives that dry fully within 7 days.
- Be careful not to damage the surface treatment of the steel product or any of its components.
- Do not use aggressive cleaning products, in particular check that their pH value falls between 6 and 11.

**IMPORTANT**

- The salt used on roads to prevent ice build-up damages the galvanic lining!
- When installing the channels pay attention that any bodies or debris do not slip into the channel.

The "Installation Directions" in this technical section are given as examples to enable the end installer to have the main guidelines on how to operate.

Special cases or specific site requirements should be evaluated by Gridiron SPA in consultation with the designer.

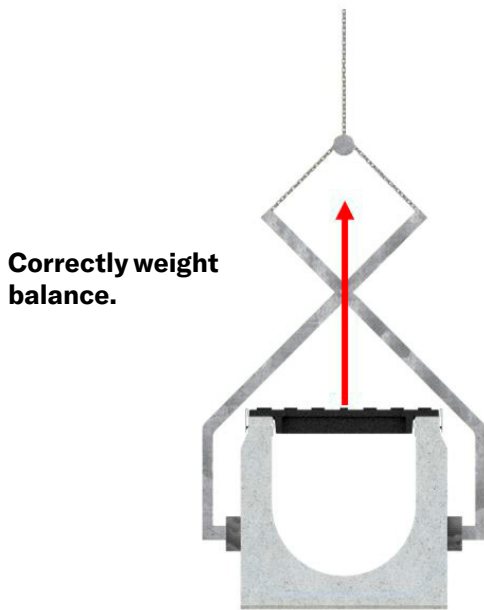

**Figure 1**

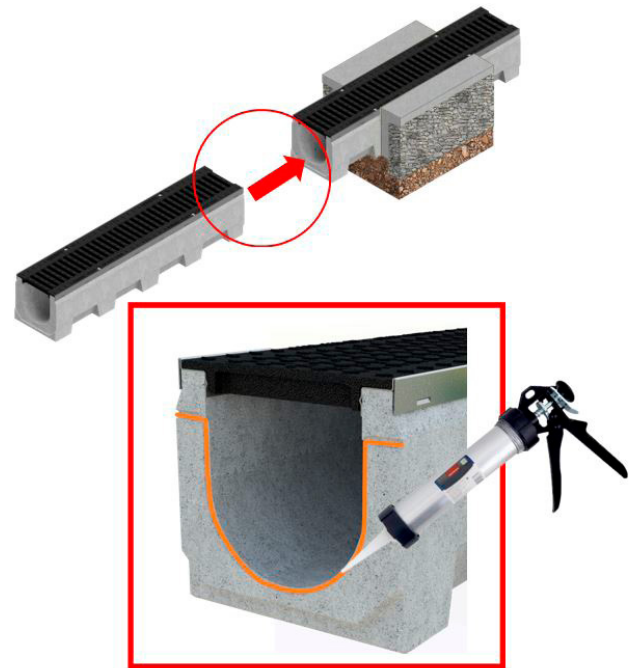

**Figure 2**

**MAINTENANCE**

- Clean the housing of the bolt that fastens the grating, if present.
- Replace any rusted nuts and bolts. this channel also allows for replacing the fastening nut.
- Remove the grating using a tool having an insert suited to the type of fastening.
- Clean the grating containment profiles with the aid of a trowel.
- Clean the inside of the channel by removing any debris, leaves, stones, gravel, etc.
- Before assembling the gratings again, lubricate the threads lining the bolt slots.

**DISPOSAL**

Regarding disposal, consult the applicable regulations for recovering any materials compatibly with the environment, and observe all local regulations.

Moreover, we recommend contacting a specialised waste disposal company.

## ASPHALT PAVING

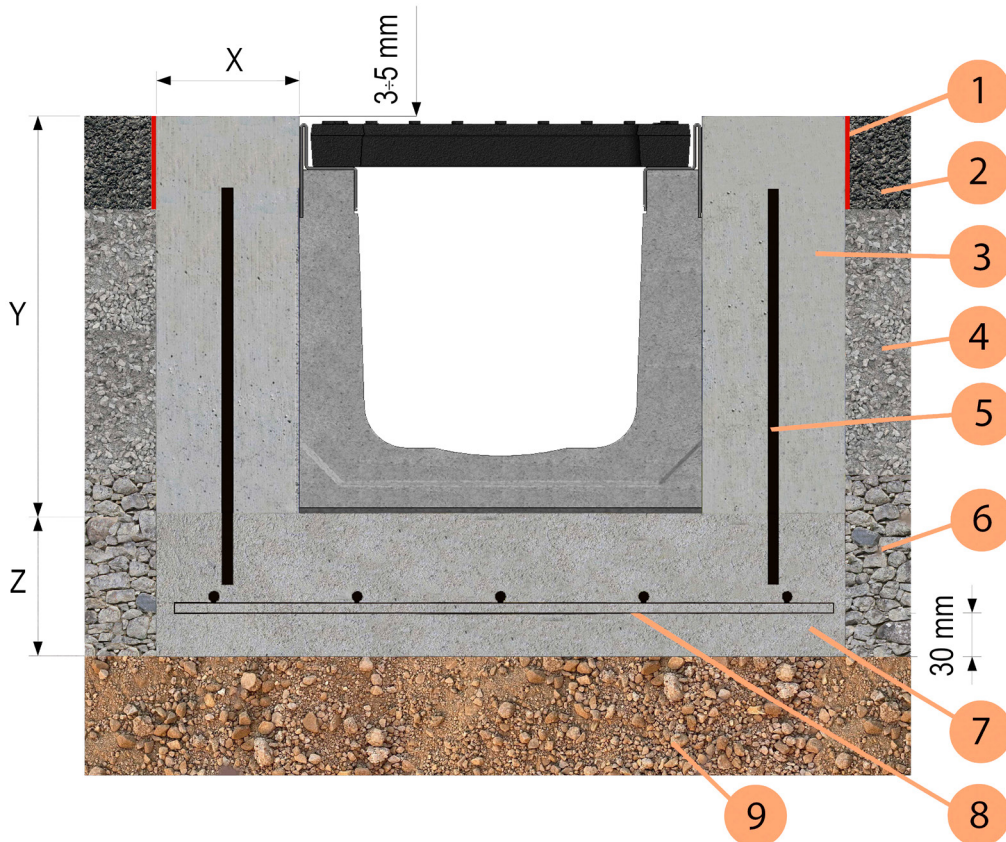

<b>1</b>	Expansion joint
<b>2</b>	Asphalt paving
<b>3</b>	Concrete reinforcement
<b>4</b>	Filler
<b>5</b>	Steel wire reinforcement
<b>6</b>	Ballast
<b>7</b>	Concrete substrate
<b>8</b>	Steel wire reinforcement
<b>9</b>	Ground

Loading class according to the standard EN 1433:2008	E600 - EN 1433:2008
<b>Minimum strength class of concrete without the risk of freezing (UNI-EN 206-1)</b>	>= C25/30 XF2
<b>Minimum strength class of concrete with risk of freezing (UNI-EN 206-1)</b>	>= C30/37 XF4
<b>X (Width mm minimum)</b>	>= 100 mm
<b>Y (Height mm minimum)</b>	(*) CHANNEL HEIGHT + 3/5 mm
<b>Z (Minimum mm thickness)</b>	>= 100 mm
<b>Steel wire reinforcement</b>	Grating Ø8 mesh 100 mm x100 mm
<b>Steel wire reinforcement</b>	Vertical bar Ø8 every 250 mm

**CONCRETE PAVING**

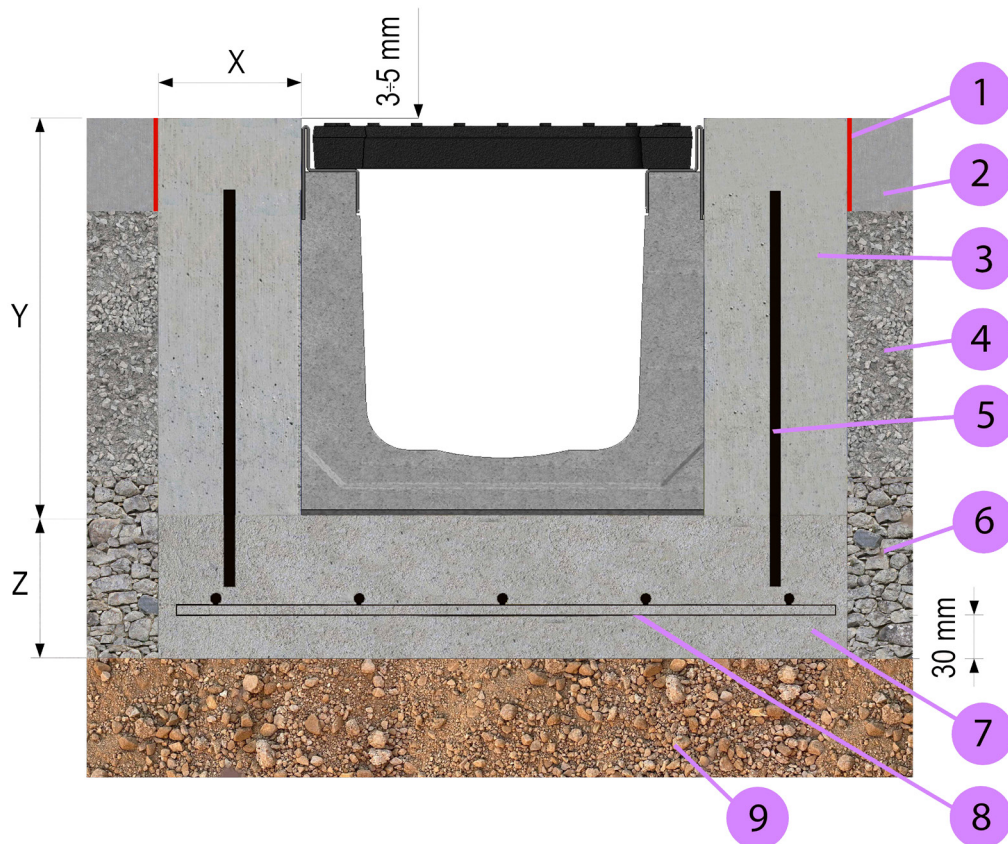

<b>1</b>	Expansion joint
<b>2</b>	Concrete paving
<b>3</b>	Concrete reinforcement
<b>4</b>	Filler
<b>5</b>	Steel wire reinforcement
<b>6</b>	Ballast
<b>7</b>	Concrete substrate
<b>8</b>	Steel wire reinforcement
<b>9</b>	Ground

Loading class according to the standard EN 1433:2008	E600 - EN 1433:2008
<b>Minimum strength class of concrete without the risk of freezing (UNI-EN 206-1)</b>	>= C25/30 XF2
<b>Minimum strength class of concrete with risk of freezing (UNI-EN 206-1)</b>	>= C30/37 XF4
<b>X (Width mm minimum)</b>	>= 100 mm
<b>Y (Height mm minimum)</b>	(*) CHANNEL HEIGHT + 3/5 mm
<b>Z (Minimum mm thickness)</b>	>= 100 mm
<b>Steel wire reinforcement</b>	Grating Ø8 mesh 100 mm x100 mm
<b>Steel wire reinforcement</b>	Vertical bar Ø8 every 250 mm

## COBBLESTONES PAVING

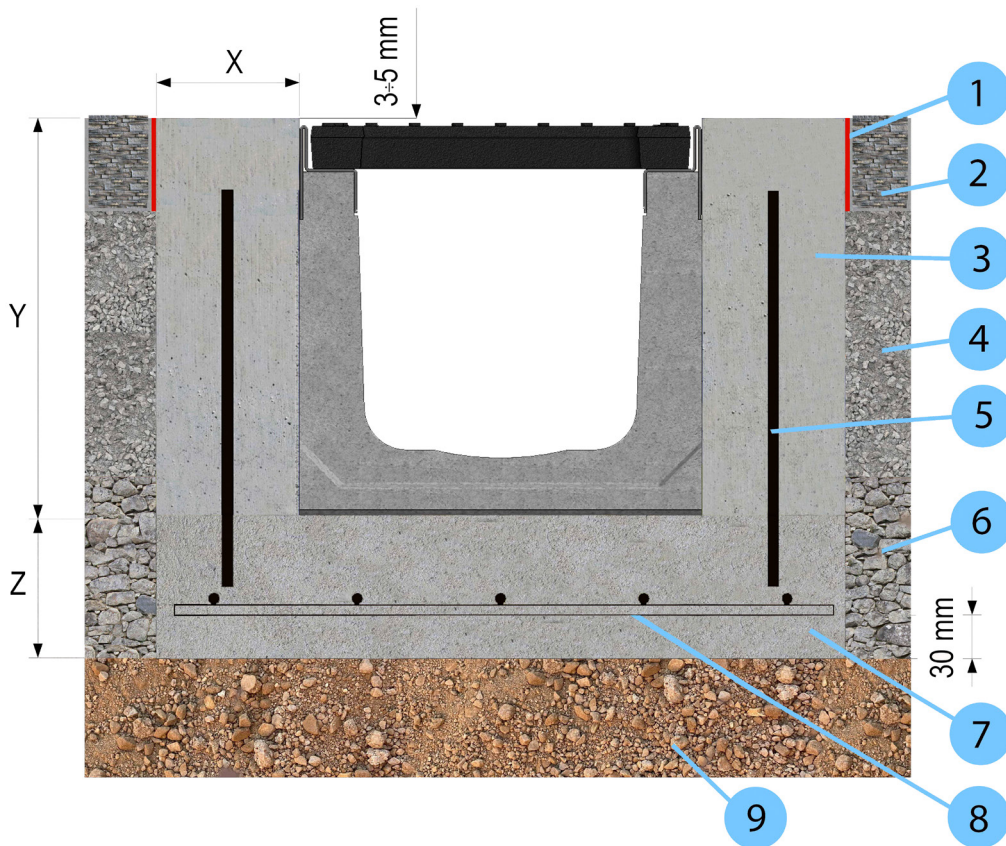

<b>1</b>	Expansion joint
<b>2</b>	Cobblestones paving
<b>3</b>	Concrete reinforcement
<b>4</b>	Filler
<b>5</b>	Steel wire reinforcement
<b>6</b>	Ballast
<b>7</b>	Concrete substrate
<b>8</b>	Steel wire reinforcement
<b>9</b>	Ground

Loading class according to the standard EN 1433:2008	E600 - EN 1433:2008
<b>Minimum strength class of concrete without the risk of freezing (UNI-EN 206-1)</b>	>= C25/30 XF2
<b>Minimum strength class of concrete with risk of freezing (UNI-EN 206-1)</b>	>= C30/37 XF4
<b>X (Width mm minimum)</b>	>= 100 mm
<b>Y (Height mm minimum)</b>	(*) CHANNEL HEIGHT + 3/5 mm
<b>Z (Minimum mm thickness)</b>	>= 100 mm
<b>Steel wire reinforcement</b>	Grating Ø8 mesh 100 mm x100 mm
<b>Steel wire reinforcement</b>	Vertical bar Ø8 every 250 mm

## FINAL THOUGHTS

The client and/or designer are responsible for verifying the bearing capacity of the soil and consequently choosing the X - Y - Z dimensions and the type of concrete.

The data in the table refer to a constant soil foundation with a good load capacity.

For any additional information, please contact the technical department.