

## USE AND MAINTENANCE

Reference	Type	Description
4R02SGPA	Channel "R" Type	R210 additivated vibrocompressed concrete drain channel, with galvanized protective edge rails, c/w pressure locked grating, bearing bar 25x2, transverse bar 10x2, mesh 33x11 (heelguard), dim. 210x1000, locked, hot-dip galvanized, runoff section sqcm. 215, loading class C250 accordingly to Standards UNI-EN 1433-2008 Norm as for installation instructions.

## INSTALLATION

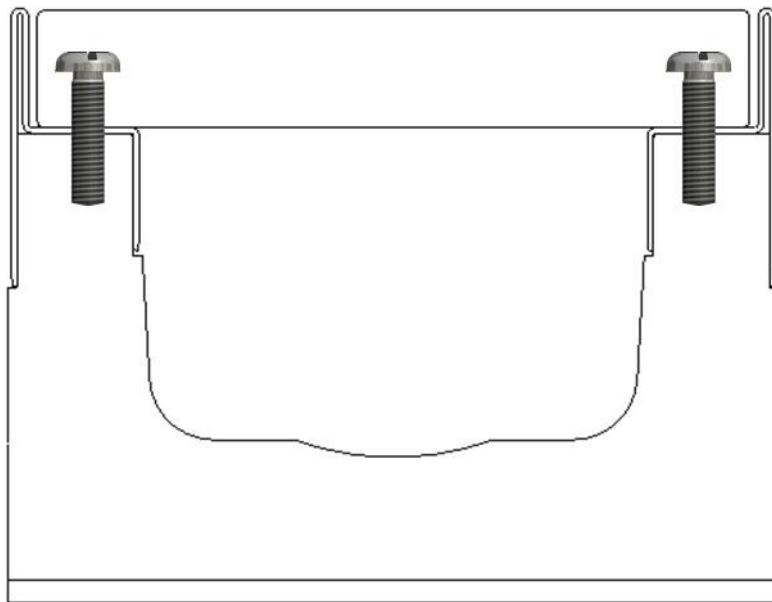

### ASPHALT PAVING



### CONCRETE PAVING



# COBBLESTONES PAVING



## **INSTRUCTION:**

Installation must be carried out by expert personnel equipped with suitable equipment for lifting heavy loads.

According to the UNI EN 1433:2008 standard, a channel's load-bearing capacity depends on the grating, the channel itself and correct installation, therefore the operations described below must be carried out with extreme care.

- 1 - Dig out a trench of suitable dimensions for housing the chosen channel.
- 2 - Cast a concrete base having the appropriate thickness and inclination, then lay the channels.
- 3 - The channels must be laid and linked to each other using the relevant male-female joint, while checking their alignment and measurements.
- 4 - Fill the sides of the channels with concrete.

## **ADVICE:**

To make the base and fill the sides, use the following types of concrete:

C25/30 XF2

C28/35 XF4 in case of temperatures  $\leq 0^{\circ}\text{C}$

- Lay the channels starting from the drainage point (sump unit).
- The channels are equipped with male-female joints at the ends, where sealant must be applied.
- It is advisable to use silicone sealant with neutral cross-linkage, which guarantees perfect adhesion and permanent elasticity (Sitol Silicon Pavimento -Torggler).
- Drill the channels using a size 8 $\times$ 10 drill bit: first mark the hole then make a pilot hole using a chisel.
- Always keep the finished paving 3-5 mm above the channel, or 10 mm in the case of asphalt paving.
- Insert the gratings in their housings prior to filling the sides of the channel; to keep them clean during laying operations, simply protect them with a PVC film.

## **WARNINGS**

- Strictly observe all the manufacturers instructions described in this document.
- Do not use the product in ways other than those for which it was intended.
- Do not in any way tamper with the channel or any of its constituent parts.
- Make sure that the product has no structural defects; if it does, immediately notify the supplier.
- Make sure that the type of item matches that requested by the designer.
- Allow the concrete to dry according to the times indicated by the producer before applying any loads.

## **GALVANISED STEEL PROFILES AND/OR COVERS**

- It is important to verify the characteristics of the adhesives used for paving, in particular that their pH value falls between 6 and 11; if not, the metal surfaces should be protected in advance with silicone spray.
- Use quick-setting adhesives, or adhesives that dry fully within 7 days.
- Be careful not to damage the surface treatment of the steel product or any of its components.
- Do not use aggressive cleaning products, in particular check that their pH value falls between 6 and 11.

## **IMPORTANT**

- The salt used on roads to prevent ice build-up damages the galvanic lining!

## **MAINTENANCE**

- Clean the housing of the bolt that fastens the grating, if present.
- Remove the grating using a tool having an insert suited to the type of fastening.
- Clean the grating containment profiles with the aid of a trowel.
- Clean the inside of the channel by removing any debris, leaves, stones, gravel, etc.
- Perform a visual inspection to check whether there are any cracks larger than 0.3 mm and, if there are,

repair them using a non-shrink cementitious mortar.

- Before assembling the gratings again, lubricate the threads lining the bolt slots.

## **DISPOSAL**

Regarding disposal, consult the applicable regulations for recovering any materials compatibly with the environment, and observe all local regulations.

Moreover, we recommend contacting a specialised waste disposal company.