

USE AND MAINTENANCE

Reference	Type	Description
4520SPS	BASE	BASE 200 polymer concrete drain channel, c/w no.2 grids in painted ductile-iron, dim. 147x500, assembled and locked, with 2 special galvanized edges. Load Class C250 accordingly to Standards UNI-EN 1433-2008 Norm as for installation instructions.

INSTALLATION

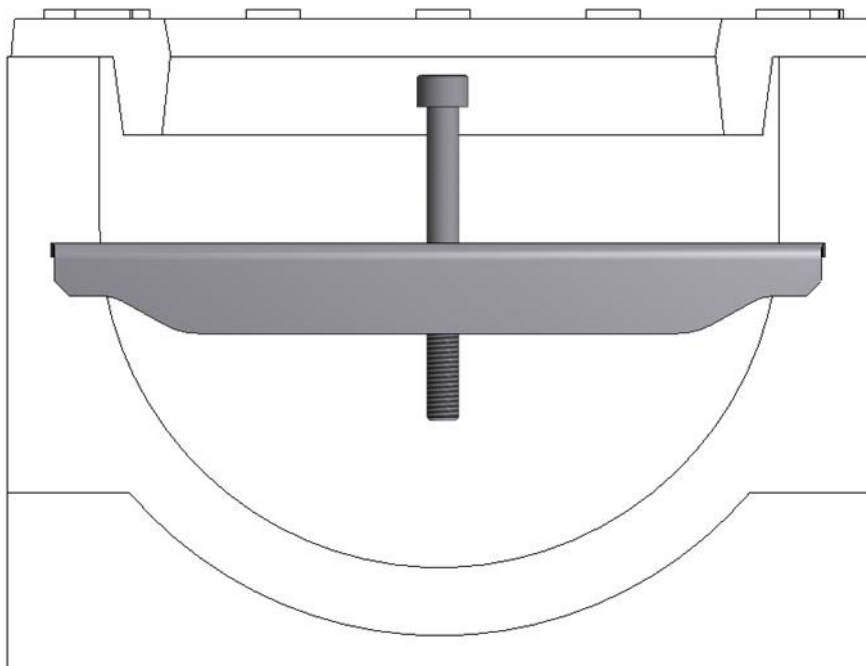

ASPHALT PAVING



CONCRETE PAVING



COBBLESTONES PAVING



INSTRUCTION:

Installation must be carried out by expert personnel equipped with suitable equipment for lifting heavy loads.

According to the UNI EN 1433:2008 standard, a channel's load-bearing capacity depends on the grating, the channel itself and correct installation, therefore the operations described below must be carried out with extreme care.

- 1 - Dig out a trench of suitable dimensions for housing the chosen channel.
- 2 - Cast a concrete base having the appropriate thickness and inclination, then lay the channels.
- 3 - The channels must be laid and linked to each other using the relevant male-female joint, while checking their alignment and measurements.
- 4 - Fill the sides of the channels with concrete.

ADVICE:

To make the base and fill the sides, use the following types of concrete:

C25/30 XF2

C28/35 XF4 in case of temperatures $\leq 0^{\circ}\text{C}$

- Lay the channels starting from the drainage point (sump unit).
- The channels are equipped with male-female joints at the ends, where sealant must be applied.
- It is advisable to use silicone sealant with neutral cross-linkage, which guarantees perfect adhesion and permanent elasticity (Sitol Silicon Pavimento -Torggler).
- Drill the channels using a size 8 \times 10 drill bit: first mark the hole then make a pilot hole using a chisel.
- Always keep the finished paving 3-5 mm above the channel, or 10 mm in the case of asphalt paving.
- Insert the gratings in their housings prior to filling the sides of the channel; to keep them clean during laying operations, simply protect them with a PVC film.

WARNINGS

- Strictly observe all the manufacturers instructions described in this document.
- Do not use the product in ways other than those for which it was intended.
- Do not in any way tamper with the channel or any of its constituent parts.
- Make sure that the product has no structural defects; if it does, immediately notify the supplier.
- Make sure that the type of item matches that requested by the designer.
- Allow the concrete to dry according to the times indicated by the producer before applying any loads.

GALVANISED STEEL PROFILES AND/OR COVERS

- It is important to verify the characteristics of the adhesives used for paving, in particular that their pH value falls between 6 and 11; if not, the metal surfaces should be protected in advance with silicone spray.
- Use quick-setting adhesives, or adhesives that dry fully within 7 days.
- Be careful not to damage the surface treatment of the steel product or any of its components.
- Do not use aggressive cleaning products, in particular check that their pH value falls between 6 and 11.

IMPORTANT

- The salt used on roads to prevent ice build-up damages the galvanic lining!

MAINTENANCE

- Clean the housing of the bolt that fastens the grating, if present.
- Remove the grating using a tool having an insert suited to the type of fastening.
- Clean the grating containment profiles with the aid of a trowel.
- Clean the inside of the channel by removing any debris, leaves, stones, gravel, etc.
- Perform a visual inspection to check whether there are any cracks larger than 0.3 mm and, if there are,

repair them using a non-shrink cementitious mortar.

- Before assembling the gratings again, lubricate the threads lining the bolt slots.

DISPOSAL

Regarding disposal, consult the applicable regulations for recovering any materials compatibly with the environment, and observe all local regulations.

Moreover, we recommend contacting a specialised waste disposal company.