

SCHEDA PRODOTTO

CODICE	5656
	CASSETTA, per riparo contatori, in lamiera aluzinc, ad una anta incernierata completa di serratura, priva di schienale.
TIPOLOGIA	Cassette Gas
MATERIALE	Lamiera Aluzinc
SPESSORE	6/10

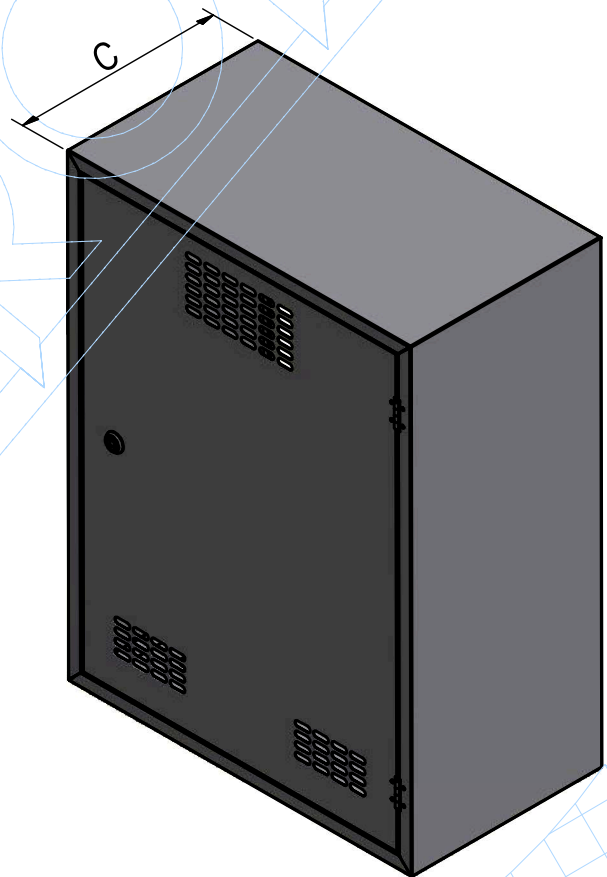
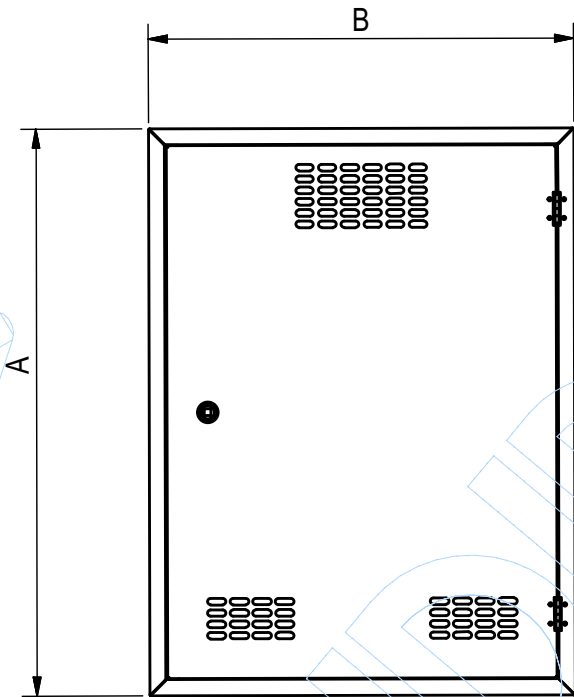

A	B	C	D
ALTEZZA MM	LARGHEZZA MM	PROFONDITA MM	PESO KG
600	450	250	4.74