

TECHNICAL SHEET

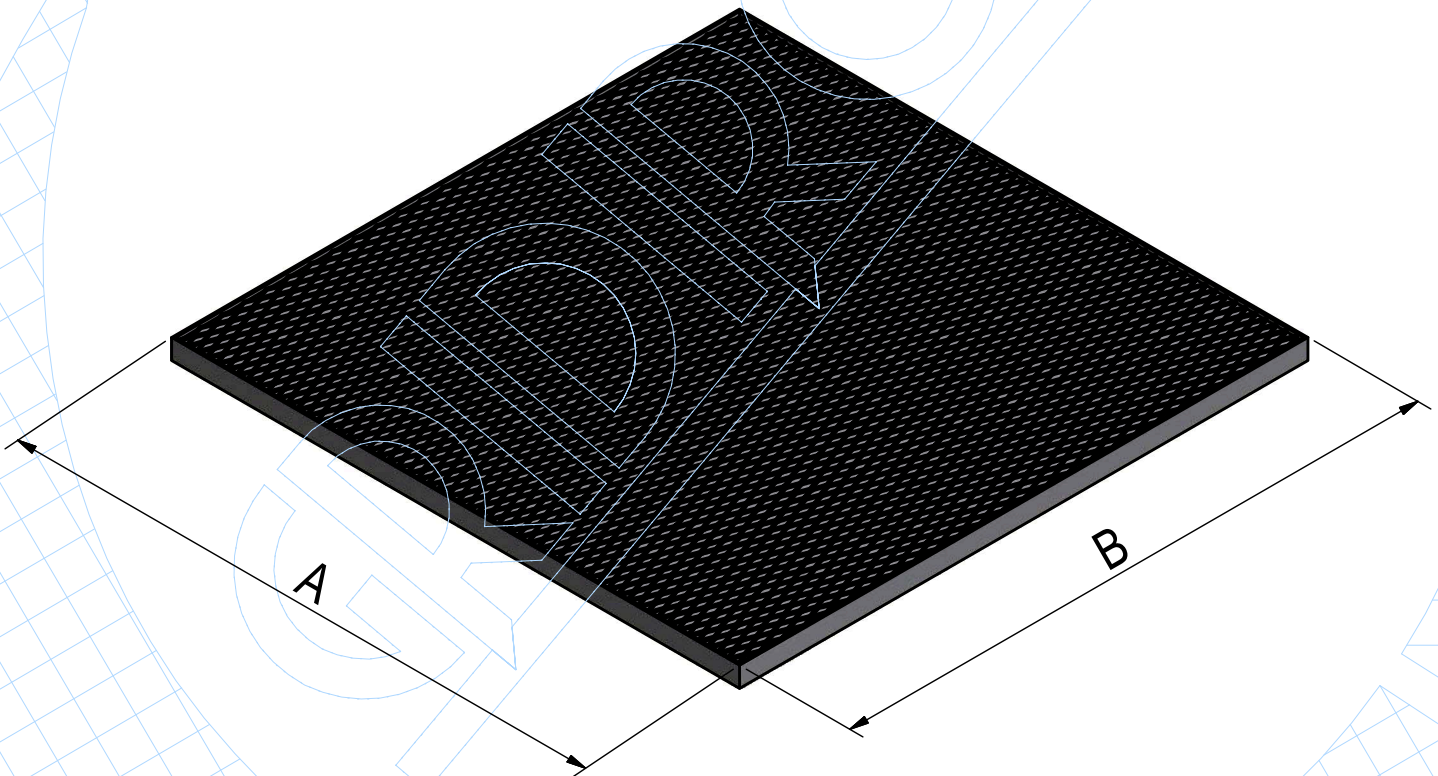

CODE	5586
	SHOPPING SPECIALE model CUNEO H=30 3+2 chequered metal sheet WEDGE w/20x3 plate reinforcements and edging, hot-dip galv., incl. 30/10-thick frame.
TYPE	Metal sheet
MATERIAL	S235JR - EN 10025:2005
SURFACE FINISH	Hot dip galvanized - UNI 1461
LOADING CLASS	Class A15
NORM	UNI EN124:1995
COMPONENTS	Lam.Striata 3+2 con Piatti 20x3

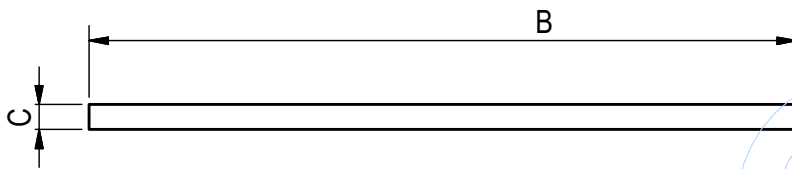

A	B	C	D
LENGHT MM	WIDTH MM	HEIGHT MM	WEIGHT KG
700	700	30	0