

TECHNICAL SHEET

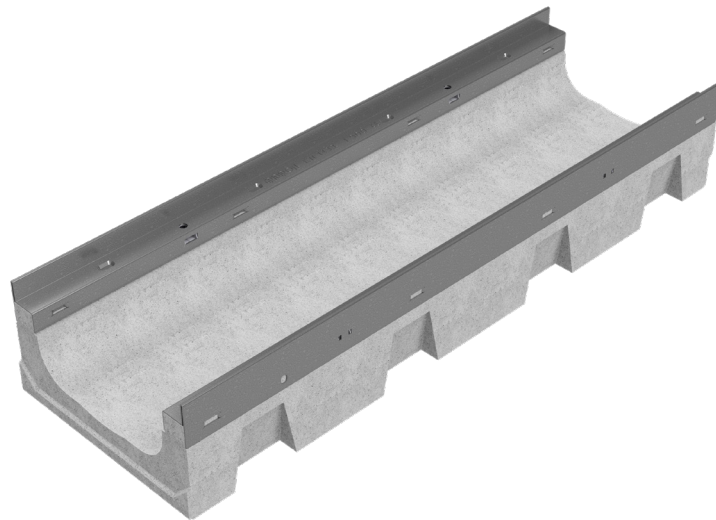

CODE	4R041S
DESCRIPTION	Vibro-compressed concrete channel MOD. R315 (H2), H=176 mm, with galvanized protective edge rails, suitable for grating dim.315x1000 H30 mm. Channel runoff section cm ² 224. Load class F900 according to EN 1433:2008 Norm, if installed following manufacturer instructions.
PRODUCT LINE	Drainage channel type "M"
MATERIAL	Vibro-compressed Concrete
SERIES TYPE	R series 315
SECTION TYPE	H2
PROFILE TYPE	Galvanized edge
VERSION TYPE	Normal without built-in slope
STANDARD	EN 1433:2008
LOADING CLASS	F900 - EN 1433:2008
INTENDED USE OR USES OF THE PRODUCT	Collection and channelling of surface water into areas subject to pedestrian and/or vehicle traffic according to the indicated flow rate.
DURABILITY	Grades of weathering resistance: W +R (§6.3.3.3 EN 1433:2008)

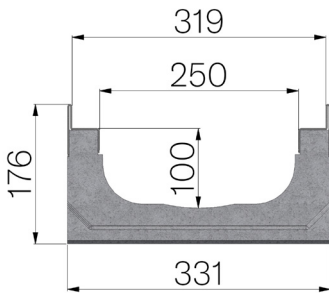

Article dimensions mm	Inner width mm	Runoff section cmq	Weight Kg/each
1000 x 331 x H 176	250	224	64,4