

TECHNICAL SHEET

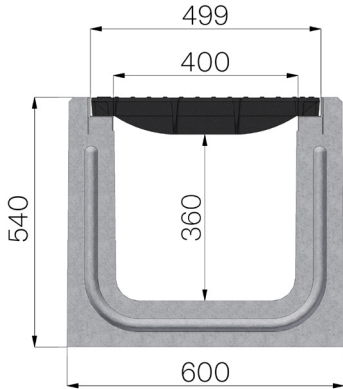

ASSEMBLED CODE	4110SGE
DESCRIPTION	Self-supporting reinforced concrete channel TYPE I, mod. I400, c/w protective edge rails galvanized and ductile iron grating loading class E600 as per EN 1433 Norm.
STANDARD	EN 1433:2008
LOADING CLASS	E600 - EN 1433:2008
INTENDED USE OR USES OF THE PRODUCT	Collection and channelling of surface water into areas subject to pedestrian and/or vehicle traffic according to the indicated flow rate.
DURABILITY	Grades of weathering resistance: W +R (§6.3.3.3 EN 1433:2008)
QUANTITY PER PACK	2
1) CHANNEL	4110S
MATERIAL	Vibro-compressed reinforced concrete
SERIES TYPE	I series 400
SECTION TYPE	H1
PROFILE TYPE	Galvanized edge
VERSION TYPE	Normal without built-in slope
2) GRID	4R10GS1
GRID TYPE	Ductile-iron Grid
MATERIAL	Ductile-Iron GJS500-7 : EN1563
SURFACE FINISH	Paint coating



Article dimensions mm	Inner width mm	Runoff section cmq	Weight Kg/each
2000 x 600 x H 540	400	1.557	976,58