

## TECHNICAL SHEET

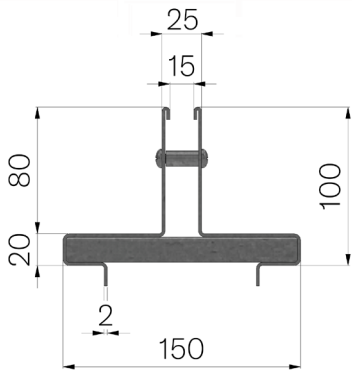

<b>CODE</b>	4F00T1
<b>DESCRIPTION</b>	Galvanized steel brickslot cover mod. THIN H80, th. 20/10, with 15 mm central slot, height 80+20 mm, for channels MOD. VIBRO-BASE 100.
<b>PRODUCT LINE</b>	Galvanized THIN covers
<b>MATERIAL</b>	Metal sheet DX51D - EN 10346/EN 10143
<b>SURFACE FINISH</b>	Galvanized Z200 - EN 10346
<b>STANDARD</b>	EN 1433:2008
<b>INTENDED USE OR USES OF THE PRODUCT</b>	Collection and channelling of surface water into areas subject to pedestrian and/or vehicle traffic according to the indicated flow rate.
<b>DURABILITY</b>	Galvanized surface as per standard EN ISO 1461. Galvanizing durability according to EN ISO 14713.
<b>LOADING CLASS</b>	D400 - EN 1433:2008



Article dimensions mm	Slot size mm	Thickness mm	Weight Kg/each
150 x 1000 x H 80	15	2	6,67