

TECHNICAL SHEET

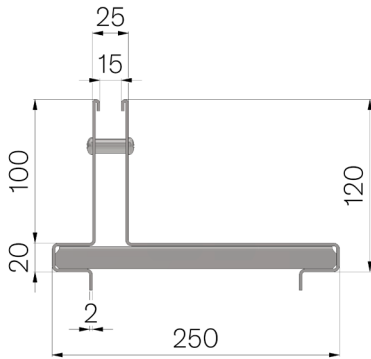

CODE	4520IL2
DESCRIPTION	AISI 304 stainless steel brickslot cover mod. THIN H100, th. 20/10, with 15 mm side slot, height 100+20 mm, for channel MOD. BASE 200.
PRODUCT LINE	THIN cover
MATERIAL	Inox AISI 304 - X5 CrNi 18 10
STANDARD	EN 1433:2008
INTENDED USE OR USES OF THE PRODUCT	Collection and channelling of surface water into areas subject to pedestrian and/or vehicle traffic according to the indicated flow rate.
DURABILITY	PREN (Pitting Resistance Equivalent Number) = 17,00 - 21,26
LOADING CLASS	D400 - EN 1433:2008



Article dimensions mm	Slot size mm	Thickness mm	Weight Kg/each
250 x 1000 x H100	15	2	9,66