

TECHNICAL SHEET

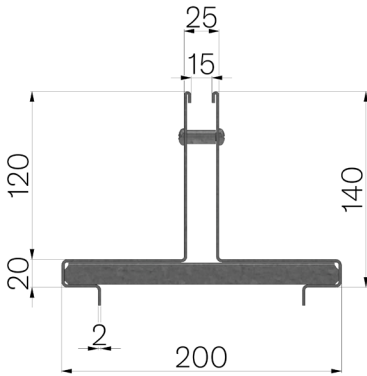

CODE	4511T3
DESCRIPTION	Galvanized steel brickslot cover mod. THIN H120, th. 20/10, L. 500 mm, with 15 mm central slot, height 120+20 mm, for channels MOD. BASE 150 (L. 500 mm version).
PRODUCT LINE	Galvanized THIN covers
MATERIAL	Metal sheet DX51D - EN 10346/EN 10143
SURFACE FINISH	Galvanized Z200 - EN 10346
STANDARD	EN 1433:2008
INTENDED USE OR USES OF THE PRODUCT	Collection and channelling of surface water into areas subject to pedestrian and/or vehicle traffic according to the indicated flow rate.
DURABILITY	Galvanized surface as per standard EN ISO 1461. Galvanizing durability according to EN ISO 14713.
LOADING CLASS	D400 - EN 1433:2008



Article dimensions mm	Slot size mm	Thickness mm	Weight Kg/each
200 x 500 x H 120	15	2	3,84