

TECHNICAL SHEET

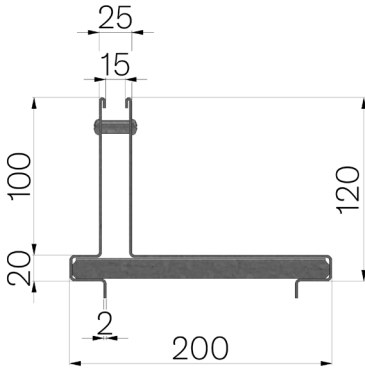

CODE	4510L2
DESCRIPTION	Galvanized steel brickslot cover mod. THIN H100, th. 20/10, with 15 mm side slot, height 100+20 mm, for channel MOD. BASE 150.
PRODUCT LINE	Galvanized THIN covers
MATERIAL	Metal sheet DX51D - EN 10346/EN 10143
SURFACE FINISH	Galvanized Z200 - EN 10346
STANDARD	EN 1433:2008
INTENDED USE OR USES OF THE PRODUCT	Collection and channelling of surface water into areas subject to pedestrian and/or vehicle traffic according to the indicated flow rate.
DURABILITY	Galvanized surface as per standard EN ISO 1461. Galvanizing durability according to EN ISO 14713.
LOADING CLASS	D400 - EN 1433:2008



Article dimensions mm	Slot size mm	Thickness mm	Weight Kg/each
200 x 1000 x H100	15	2	6,91