



S0005 1 section armrest L/R TD (118/119)

SPAREPARTS & REPAIR / RESERVDELAR & REPARATION

For further information about your furniture and care advise.
För mer information och skötsel av din möbel.

www.scapainter.com

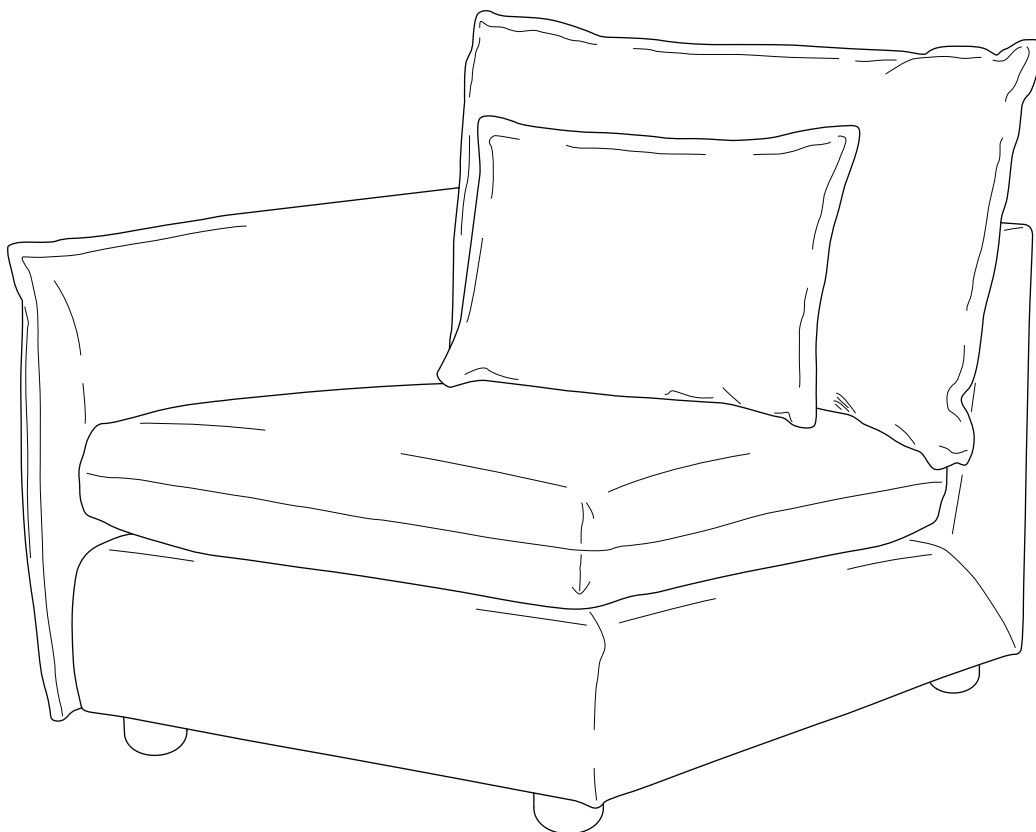

Scapa®

YOU NEED / DU BEHÖVER

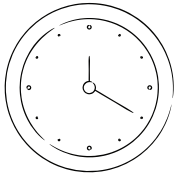

ca 30 min

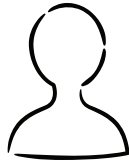

1-2 person / 1-2 person

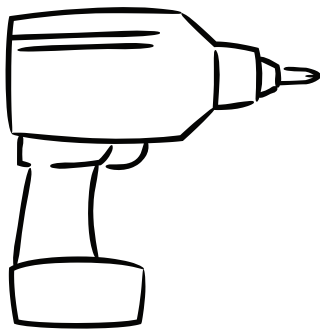

10 mm

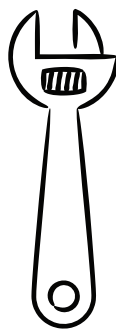
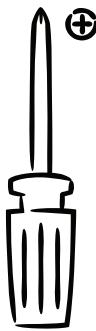

6 mm / 8 mm

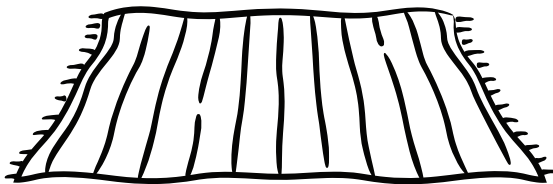

Place your product on a soft surface when assembling.

Lägg dina produkter på ett mjukt underlag när du monterar.

QUESTIONS? / FRÅGOR?

Do you have questions about the assembly or maintenance of your furniture?

Check out **scapainter.com** or contact your retailer for further help and guidance.

Har du frågor kring montering eller skötsel av din möbel? Kika in på **scapainter.com** eller kontakta din återförsäljare för ytterligare hjälp och vägledning.



SPAREPARTS

S0005 1 section armrest L/R TD (118/119)

LEGS / BEN

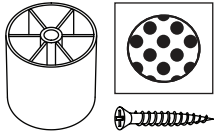

5 cm

ARMRESTS / ARMSTÖD



15 cm

FRAMES / STOMMAR

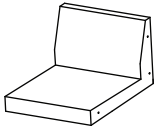

750 section

FITTINGS / BESLAG



Pin

Insert nut

Connect fitting

CUSHIONS & COVERS / PLYMÅER & KLÄDSLAR



A 750 mm

B 750 mm

C 640

NOZAG SPRINGS & FITTINGS / NOZAGFJÄDRAR & FÄSTEN

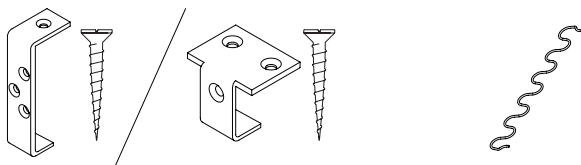

Nozag spring clip

570 nozag spring

INSERT NUT INSTALLATION / MONTERING AV RAMPAMUFF

Follow the instruction step by step.

1. **M8 insert nut.** Screw in the M8 insert nut using an 8 mm allen key.

2. **M6 insert nut.** Enlarge the existing hole in the frame using a 10 mm drill bit. Screw in the M6 insert nut using a 6 mm allen key.

Följ instruktionerna steg för steg.

1. **Rampamuff M8.** Gänga i M8 rampamuffen med en 8 mm insexnyckel.

2. **Rampamuff M6.** Förstora det befintliga hålet i stommen med en 10 mm borrh. Gänga i M6-rampamuffen med en 6 mm insexnyckel.

1.

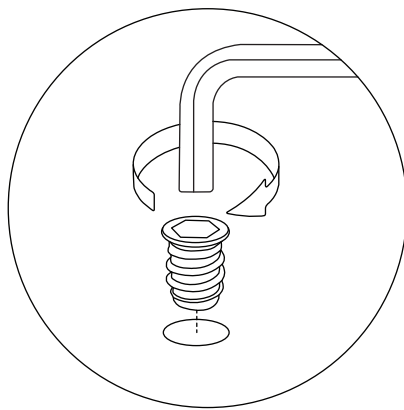

2.

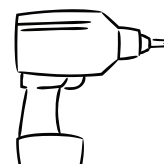
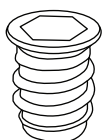
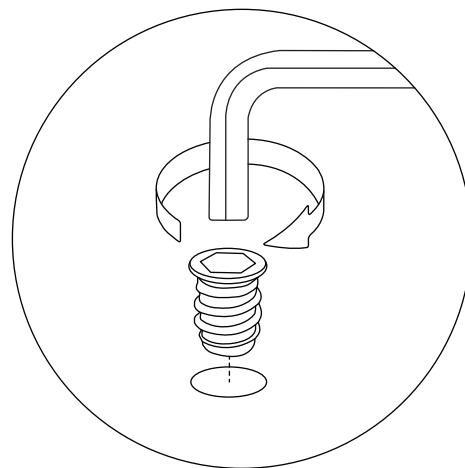
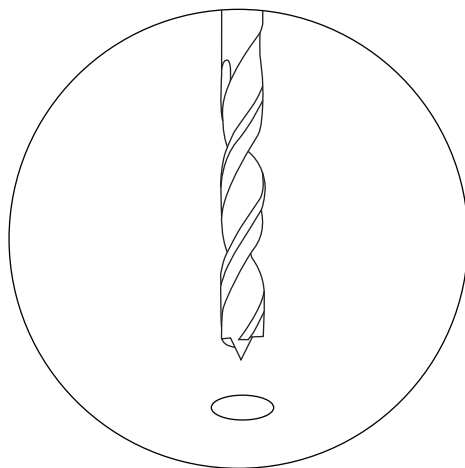

REPLACING THE NOZAG CLIP / BYTE AV NOSAGFÄSTET

Follow the instruction step by step.

1. Attach the new nozag clip using wood screws.
2. Pull and hook the nozag spring into place.

Följ instruktionerna steg för steg.

1. Fäst fast det nya nosagfästet med hjälp av träskruvar.
2. Dra nosagfjädersnåren på plats.

1.

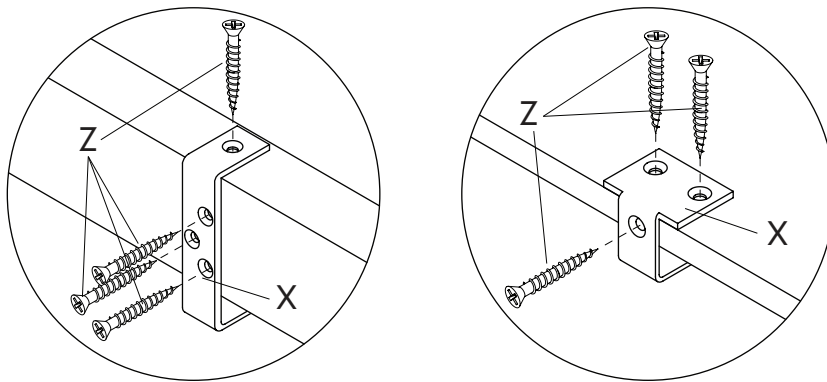

2.

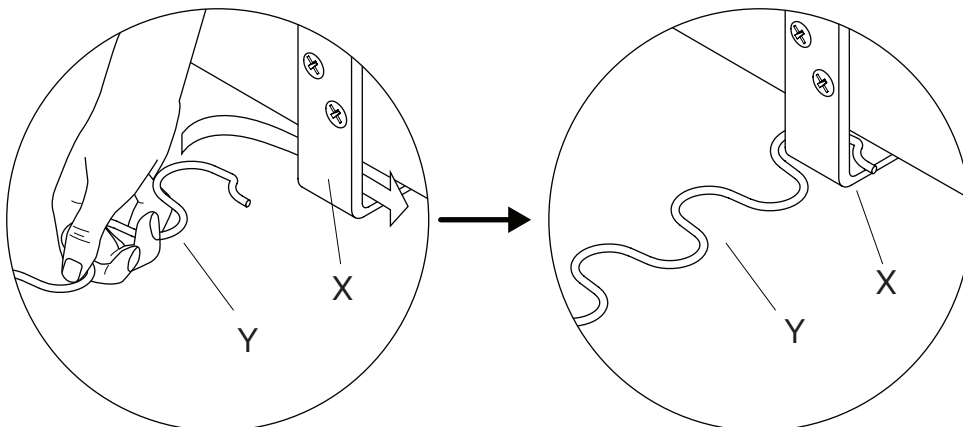

X

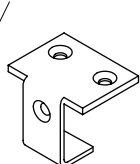
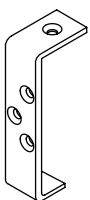

Y

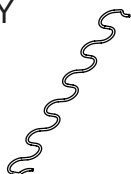

Z

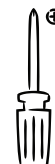

ARMREST INSTALLATION / MONTERING AV ARMSTÖD

Follow the instruction step by step.

Följ instruktionerna steg för steg.

1.

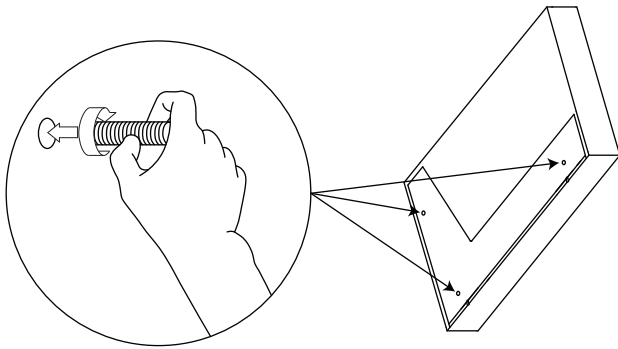

2.

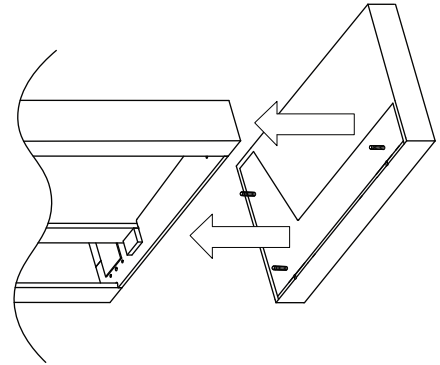

3.

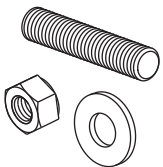
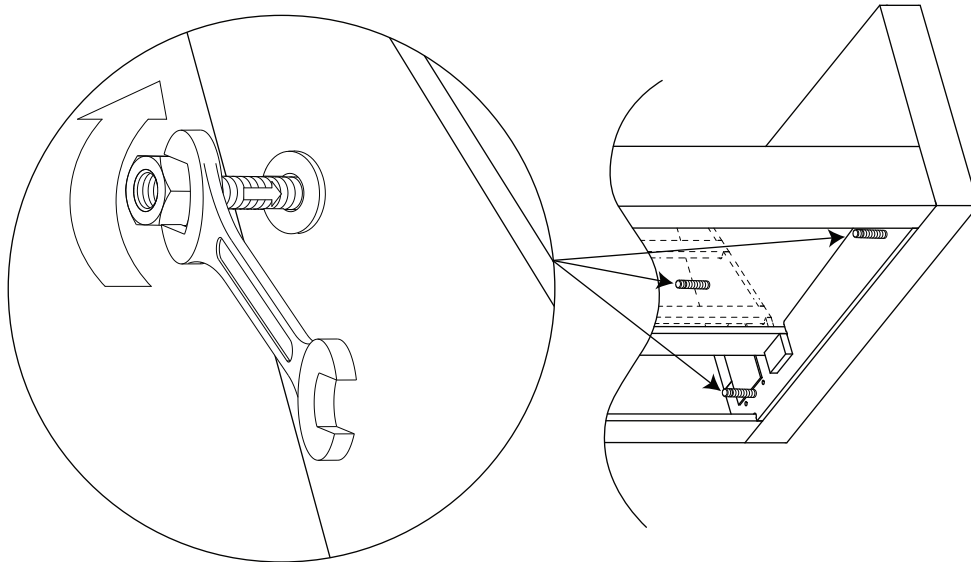

REMOVING THE ARMREST / DEMONTERING AV ARMSTÖD

Follow the instruction step by step.

Följ instruktionerna steg för steg.

1.

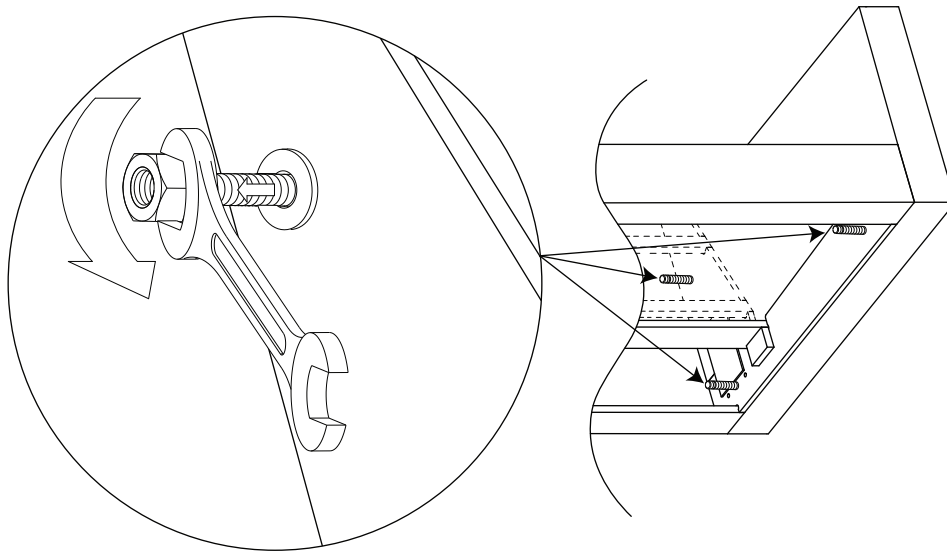

2.

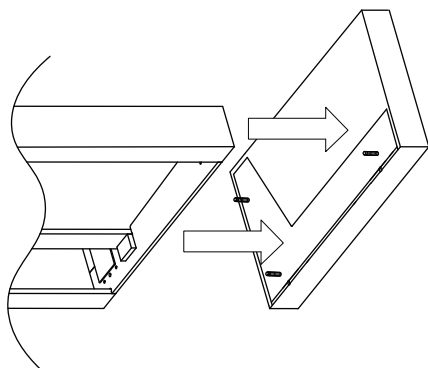

3.

